

1. Brief Introduction

EM613001 is a DC metering device that uses shunt sampling. Support RS485 communication, communicate with the concentrator (EM613002, one NB concentrator can connect 25 RS485 DC meters) through RS485, upload data to the system platform (currently our existing platform can perform simple data reading and parameter setting, it is recommended The customer independently develops the system platform according to the actual needs), and the simple data reading can use the supporting PC software. Din rail type installation, with good reliability, small body, beautiful appearance, easy installation and so on.

2. Technical Parameter

Voltage	DC40V~400V (It must be within this range, not less than 40V, the measurement voltage is self-powered)
Current	10A~240A (the accuracy might be effected if less than 10A)
Impulse Constant	100 imp/kWh
LCD Display	LCD 6+2
Temperature Range	-20~70℃
Annual Average Humidity	75%
Maximum Humidity	95%
Accuracy Class	Cl1.0
Communication	RS485, protocol DLT645-2007 (9600 baud rate)
Power Consumption	≤8VA ≤0.4W
Standard	GB/T 17708-2017 (Static DC energy meter)

Cl1.0 DC meter accuracy error

Current Value	Percentage of error of Cl1.0 energy meter
$0.05I_b \leq I < 0.1I_b$	±1.5
$0.1I_b \leq I < I_{max}$	±1.0

3. Function Description

- RS485 communication : Support RS485 communication for setting and reading, DLT645 protocol compatible.
- Direct current metering: high accuracy of shunt sampling, DC energy, current, voltage can be measured.
- Tariff: 4 tariffs, 8 time intervals
- Alarm function: over-under-voltage, over-current alarm, the threshold can be set.

- Event record: the last 20 records stored by the device itself when overvoltage and overcurrent occur.
- Display: LCD displays DC power, current, voltage, tariff power, data wheel display (time interval 5S), and pages can also be turned by pressing external buttons.
- FW Upgrade: RS485 communication for local upgrade.
- Backlight: Press the page turning button to turn on the backlight, which is convenient for viewing data when the light is insufficient.
- Alarming function: over-voltage(Code01), under-voltage(Code02), over-current(Code04), threshold can be defined.

4. Overall Dimension

A : LCD Display

B : Single Press for Paging, Long Press for Function

C : Impulse Indication



Material

Base : PC+ABS

Face cover : PC+ABS

Side cover : PC+ABS

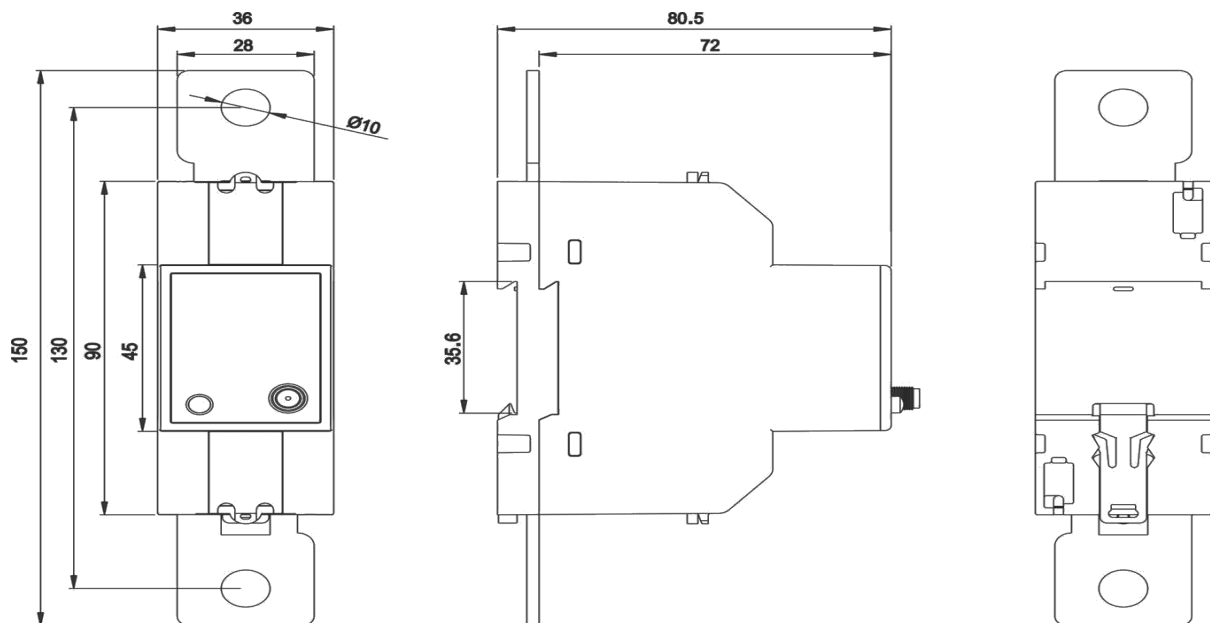







Length 150mm, Width 36mm, Height 80.5mm

5. LCD Display

Button Function and Display

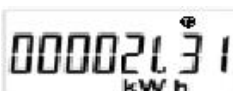
First layer content (Electrical information)

Page	Content	Display
1 st Page	Energy (kWh)	
2 nd Page	Voltage (V)	
3 rd Page	Current (A)	
4 th Page	Tariff Energy T1	
5 th Page	Tariff Energy T2	
6 th Page	Tariff Energy T3	
7 th Page	Tariff Energy T4	



Single-click button to turn pages

Press and hold the button for 5S on any page to enter the metering device information (second layer)

Second Layer Content (Measuring device information, plz refer to practical situation)

Page	Content	Display
1 st Page	Device Serial Number	4880 150 1
2 nd Page	Software Version No.	88.88
3 rd Page	Date	00-01-01
4 th Page	Time	00:00:00

6. Wiring Diagram

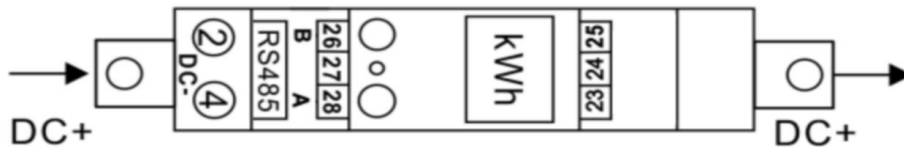

Note: 2、4 terminals are common, only need DC-, mainly used as operation voltage

Correct and Wrong Wiring Diagram

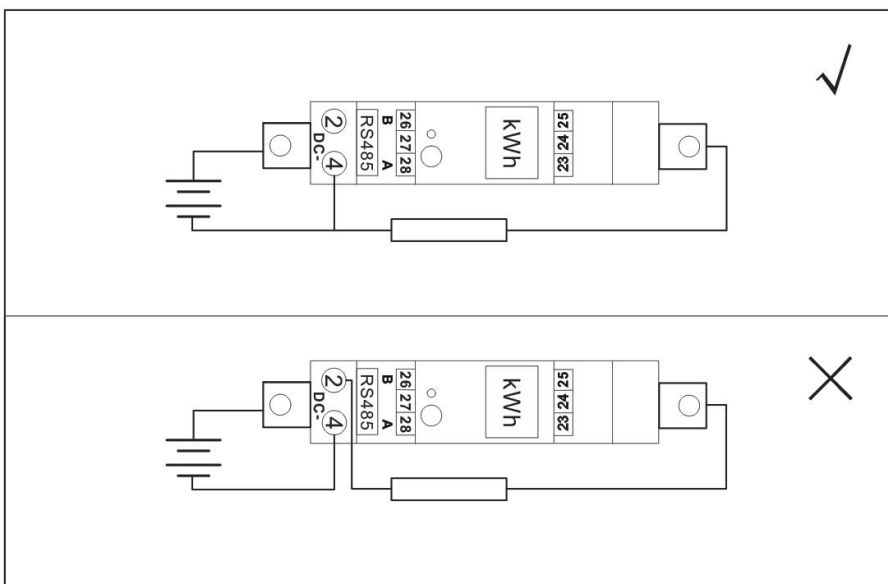

Typical Line Application (Solar Power Generation)

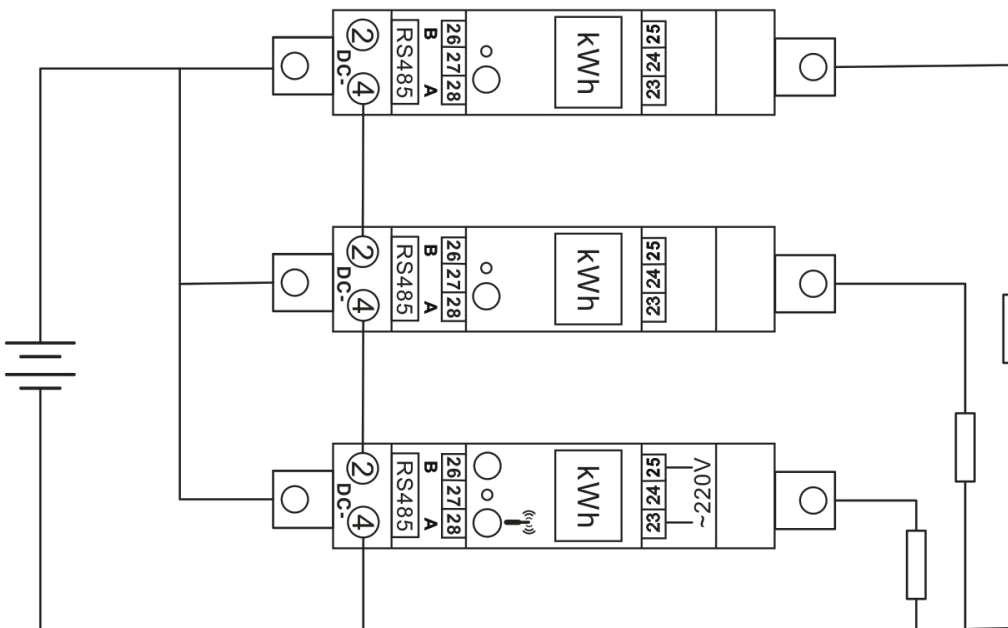

7. Install and use

7.1 Installation Instructions

- The installation of the electric energy meter requires an experienced electrician or professional, and be sure to have read this user guide;
- During the installation process, if the casing is obviously damaged due to severe impact or drop, please do not install or power on it, and contact our company in time;
- The electric energy meter has passed the inspection before leaving the factory and can be directly installed and used;
- The electric energy meter should be installed in the indoor or outdoor electric meter box. The installation base should be fixed on a solid fire-resistant wall, and there is no corrosive gas in the air;
- The electric energy meter should be wired according to the wiring diagram on the terminal button box, preferably connected with copper wire or copper terminals.

7.2 Installation Instructions

1. Take a standard guide rail (the length is customized) and fix it at the position where the meter is to be installed;
2. Push the buckle at the bottom of the meter down by one gear, as shown in Figure 1 and Figure 2;

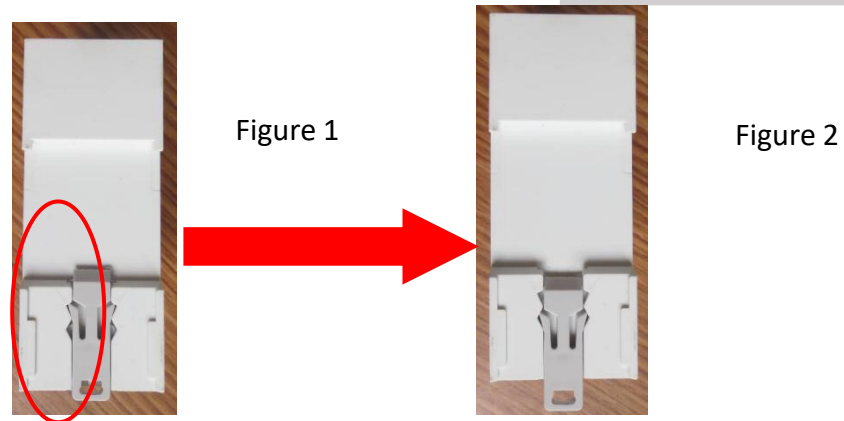

After the buckle is pushed down a gear

3. Hang the meter on the guide rail as shown in Figure 3, and then push the buckle up a gear to clamp the meter on the guide rail. As shown in Figure 4;

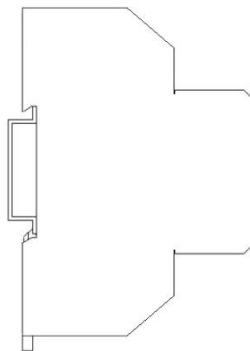

Figure 3

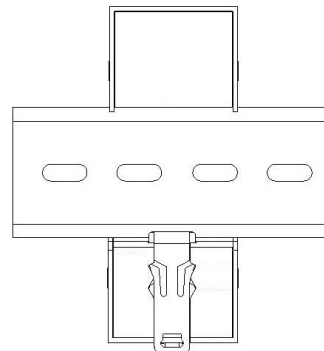

Figure 4

4. The effect after the installation is completed (Figure 5); after the wiring is completed, seal the side cover of the meter with lead as needed.



Figure 5

Note: DC+ enters at the bottom and exits at the top, DC- can give a working voltage, and the load DC- cannot be connected from the meter. 485 lines are recommended to use 2 cores
A single-strand hard wire of about 0.5mm².

7.3 Installation and use

- The voltage must be connected in strict accordance with the voltage level indicated on the label.
- When installing, the terminal must be tightened, and the metering device must be hung on a sturdy and fire-resistant screen that is not easy to vibrate. The display effect is better when the metering device is viewed downward, so it should be installed vertically, and the height should be 1.8 meters.
- Seal the end caps with lead after wiring.

8. Transportation & Storage

The electric energy meter should not be subjected to severe shock during transportation and storage, and should be transported and stored according to the provisions of *GB13384-2008 "General technical conditions for instrument packaging"*;

The electric energy meter should be kept in the original package, and temperature range of the place where it is kept is 0-40°C, the relative humidity is no more than 85% and no corrosive gas in the air;

The electric energy meter should be stored in the warehouse and put on the shelves. The stack height should not exceed 10 boxes. After unpacking, the stack height of single packed electric energy meters should not exceed 5 layers.

9. Quality Assurance

9.1 Calculation method of warranty period:

Warranty is handled according to the commercial invoice issued by our company, and the time is 18 months from the date when the meter is shipped from the warehouse, minus the maintenance time and delivery time for no spare parts.

9.2 Warranty coverage

9.2.1 When the user fully follows up the transportation, storage, installation and application of the electric energy meter, and the company's conditions of sealing integrity (in the case of no printing and dis-assembly), the electric energy meter that does not meet the quality requirements and valid evidence (For example, desks, certificate photos, feedback documents from customers' local users, relevant government departments, documents, etc.) should be provided by the customer.

9.2.2 We will repair, replace or return the meter in the following cases:

No demonstration and no prior explanation;

Does not meet the implementation standards indicated on the product or its packaging;

(If the standard on the product/package is required by the customer, but does not meet the company's product implementation standard, the customer should make a corresponding responsibility commitment)

Does not meet the quality status indicated by product instructions, physical samples, etc.

Unqualified meters should be determined in consultation with the user. Generally, we will repair or replenish in the next order. Special circumstances shall be determined through consultation between the two parties.

Note: The quality guarantee is not applicable. If there is no valid invoice, the evidence corresponding to the quality problem of the order cannot be provided, and the damage caused by force majeure or the warranty beyond the validity period, but can be recovered for repair (transportation and other related costs need to be borne by the customer).

10. Technical Support

Users' manual is mainly used to guide users to better utilize this series of meter. If unclear please contact with us at any time, we will give you a satisfactory answer.

Sales Center & Technical Support:

Ivy Metering Co.,Ltd

Add: Room 1206, AFC Grand Hongqiao International, No.999/1009 Li'an Rd, Minhang District, Shanghai, China

Tel: +86 21 62209608

Contact: Ms Angel

Email: info@ivy-metering.com